

Raychem *RPG* Limited
Electrical Products Division



*Connecting
Power
with
Reliability*



Electrical Products Division

Vision

To be the most preferred engineering solution provider to our customers in the Power Transmission and Distribution sectors, by offering technically superior products and services, at prices, that offer the best value for money in their class.



ISO 9001:2000 Certificate



ISO 14001 Certificate

Core Values:

Focus on customers.

Develop a committed and responsive community of Employees, Distributors and Vendors.

Embrace growth and productivity through Innovation and Entrepreneurship.

Communicate openly and demonstrate integrity in all our activities.

Demonstrate passion for performance through anticipation, speed and flexibility.

Protect the environment and contribute to society around us.



Best Corporate Performance Award 2001



CI-Exim Bank's "Commendation Certificate For Strong Commitment to TQM 2001 & 2003"

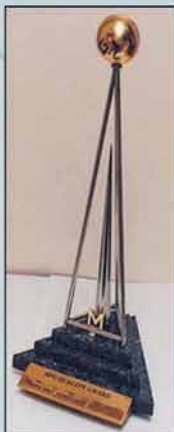

RPG Quality Award 2001



RPG Quality Award 2004 Certificate of Merit

CONTENTS

<i>Enhancing the reliability of cable networks</i>	4
<i>Low Voltage Terminations & Joints</i>	5
<i>Medium Voltage Terminations</i>	6
<i>Switchgear Terminations</i>	7
<i>Medium Voltage Joints</i>	8 - 9
<i>72kV High Voltage Terminations</i>	10
<i>72kV High Voltage Joints</i>	11
<i>Raysulate</i>	12 - 13
<i>Cerasafe</i>	14
<i>Polipro</i>	15
<i>Services</i>	16 - 17
<i>Tool and Accessories</i>	18
<i>Capabilities</i>	19

Enhancing the reliability of cable networks

Raychem RPG Limited offers a comprehensive range of cable accessories for all types of cables. The most innovative utilities and industries including mining, marine, railways and offshore around the world, use Raychem Heat Shrinkable Power Cable Accessories.

Designed to withstand environmental extremes and high pollution levels over long operating lifetimes, they help maintain service reliability in both, overhead and underground installations.

Raychem has developed specially formulated insulation materials that resist tracking and degradation caused by erosion, ultraviolet light and other environmental stresses.

Raychem Heat Shrinkable Accessories have been designed to perform under different climatic conditions all over the world. They have proven field experience of over 40 years.

PRODUCT FEATURES

Basic design and material research have been improved systematically over the last four decades. Through research, in close co-operation with our customers, has produced new materials for the electrical power industry. The result is a wide range of products with unique combination of properties such as:

- **Increased resistance to thermal ageing**
- **Insulation thickness memory**
- **Shape memory**
- **Excellent resistance to surface electrical activity**
- **Improved UV performance**
- **Electrical stress control**
- **Void-free inter-facial bonding**
- **Impermeability to cable oils**
- **Moisture blocking**
- **Improved flame resistance**
- **Elastomeric technology**
- **Mechanical connecting systems**

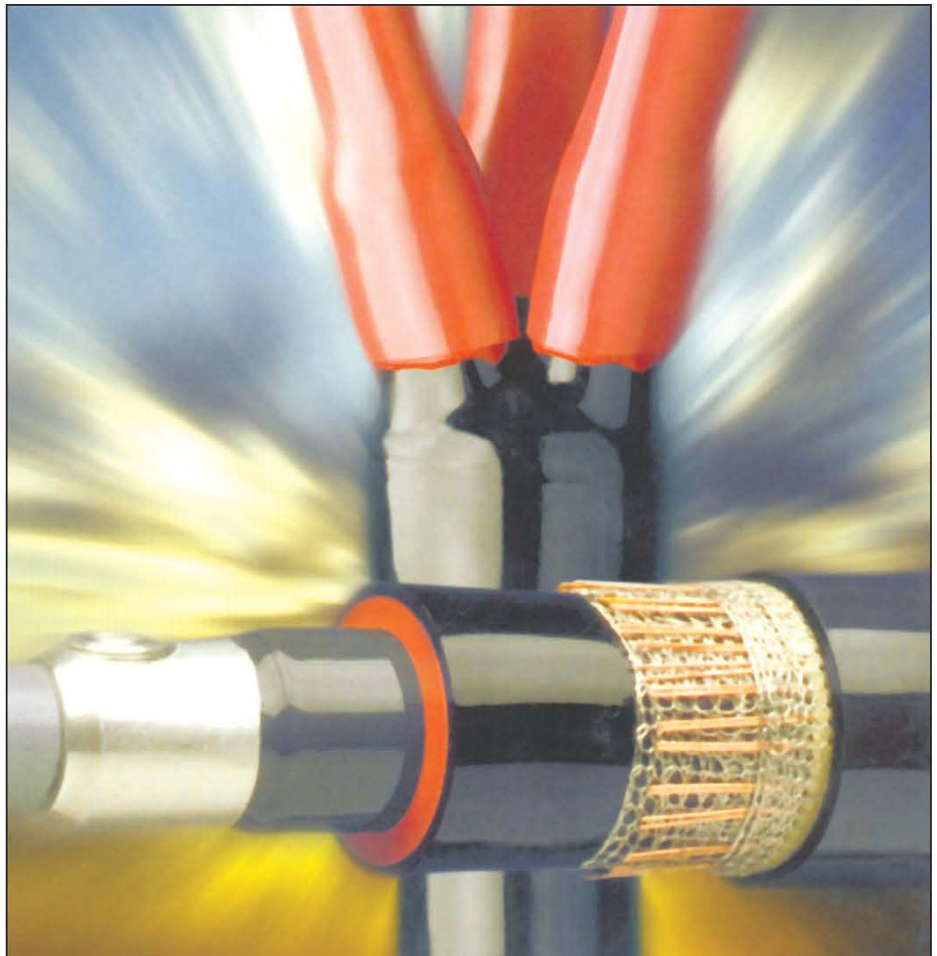

Low Voltage Terminations & Joints

Raychem Low-Voltage Terminations

The terminations are designed for 3 and 4 core polymeric insulated cables with or without armour of 3 and 4 core paper insulated cables including cables with reduced neutral conductor.

Consistent performance in harsh environments such as extreme temperatures, atmospheric pollution, and ultraviolet light has proved the reliability of Raychem terminations.

Product Features & Benefits

- Heat shrink technology
- Quick and easy installation
- Solutions for all cable constructions



Raychem Low Voltage Joints

Raychem products offer excellent insulating and sealing performance with heat shrinkable and resin materials. These proven materials form the basis of straight and branch joints for voltages up to 1kV.

- Simple and fast installation - no curing time
- Immediate backfill
- Immediate energisation
- Unrestricted shelf life (-50°C to +50°C)
- Excellent electrical insulation
- Outstanding environment resistance
- Proven mechanical strength
- Re-entry for isolation of feeder
- Slim profile



Medium Voltage Terminations

Raychem heat shrinkable termination systems for paper and polymeric insulated cables up to 33kV

Recognition of Raychem heat shrinkable material advantages for cable jointing was the starting point for the development of special polymers for use at high voltages. The resulting materials possess exceptional resistance to prolonged electrical stress and weathering, and are also capable of being shrunk down quickly to fit and seal a cable, using only a commonly available gas torch.

Product Features & Benefits

- Heat shrink and elastomeric technologies
- Impedance stress control system
- Proven anti-tracking, erosion and UV resistant insulating material for indoor and outdoor applications
- Easy and highly reliable installation
- Range taking
- Suitable for crimped, soldered and mechanical lugs
- Resistant to breakage and vandalism
- Solutions for all cable constructions

Biterm Terminations

Raychem RPG's new design of **Biterm Termination** has the following features and benefits.

- Fewer components - less time to install, lesser chance of errors in installation.
- More reliable
- Tested at CPRI as per IS 13573 with latest amendments.



Raychem Heat Shrinkable Termination installed in Switchyard

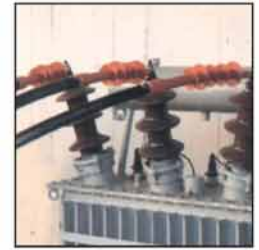

Raychem Heat Shrinkable termination shows flexibility to directly install on a transformer



Raychem 33kV termination installed on Surge Arrester which also functions as a support insulator



Raychem Heat Shrinkable HVT termination



Biterm Outdoor



Biterm Indoor

Uniterm Terminations

(Modern technology terminations)

Product Features & Benefits

- High performance termination material
- New varistor stress control system
- Compact design
- Few components
- Simple to install, high reliability
- Mechanical robustness
- Universal application
- Range taking
- No shelf life limitation
- More economical

Raychem's **Uniterm Terminations** are designed to suit modern compact equipments with less space for cable compartment. A single component replaces three heat shrinkable components (non-tracking tubing, stress control tubing, and skirts).

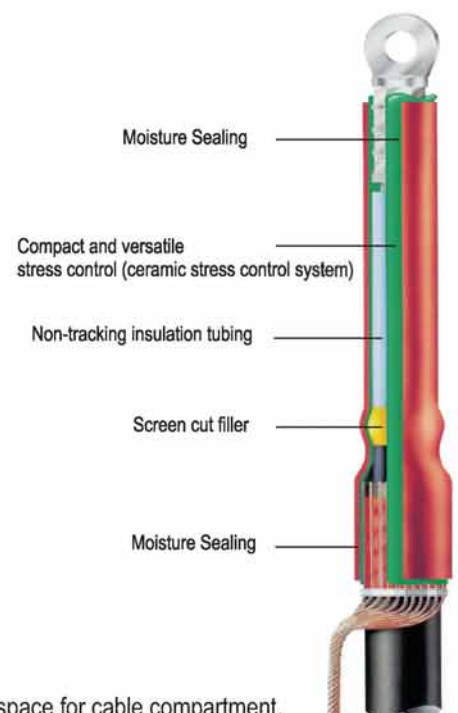

Uniterm

Switchgear Terminations

Universal adapter system installed for all types of cables and switchgears

Medium-voltage Switchgear Connection System

Raychem heat-shrink and cold-applied systems for switchgear with standardized bushings for 250A and 400/630A have been installed by utilities and industrial organisations worldwide for more than 40 years.

Product Features & Benefits

- Heat-shrink and elastomeric technologies
- Right-angle insulated boots
- Straight insulated boots
- Separable screened adaptor systems for 250A and 400/630A
- Separable insulated adaptor systems
- Suitable for crimped and mechanical lugs
- Easy and highly reliable installation
- Solutions for all cable constructions

ABB CTC

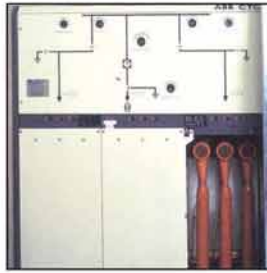

ALSTOM FBA



GEC ALSTOM T&D BTL



ABB Calor Emag ZI4



Siemens 8DJ10

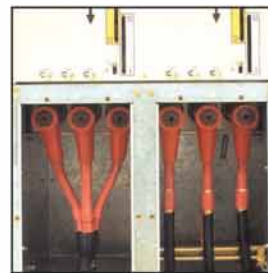

Driescher G.I.S.E.L.A



For technical information regarding connections to other switchgears, please contact your local Raychem RPG representative.

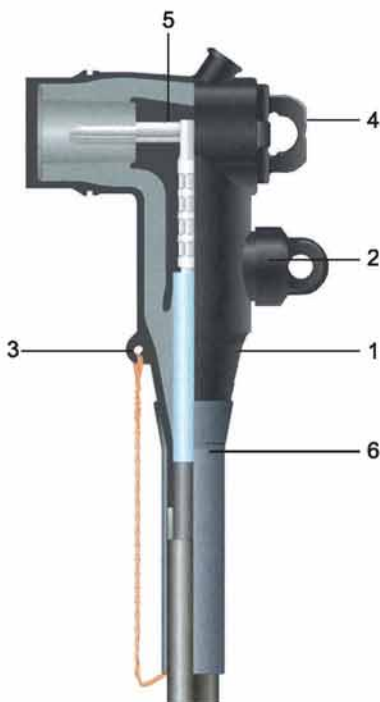

Screened Elbow Connector

Raychem reusable Screened Elbow and Straight Connectors

Product Features & Benefits

1. Screen body with integrated stress control
2. Capacitive test point
3. Earthing eye
4. Retainer connection point
5. Compression pin connector
6. Rayvolve or Heat Shrinkable sealing system

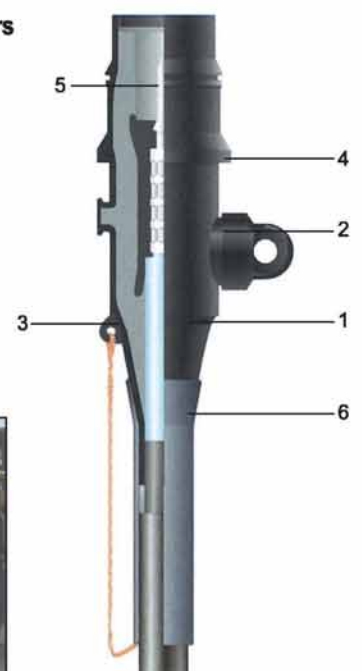

Screened Straight Connector

Medium Voltage Joints

Raychem Medium Voltage Joints

Millions of Raychem heat shrinkable medium voltage joints have been installed on paper and polymeric cables worldwide in the most severe service conditions, and under high electrical, thermal, mechanical and environmental stresses.

Product Features & Benefits

- Heat-shrink technology
- Prefabricated components
- Easy and highly reliable installation
- Applicability to different conductor and connecting techniques
- Accommodation of tolerances, range-taking
- Suitable for different conductor cross sections and cable constructions
- Solutions for all cable constructions

Design of joints

The connectors are insulated and sealed with thick-wall heat-shrinkable tubings and mastics. The armour or copper tape shielding is rebuilt with wraparound metal case or with copper mesh. A solderless earth connection provides electrical connection to the armour or copper shielding. The outer protection and sealing is performed by an adhesive coated heat-shrinkable tubing. Joints type POLJ are supplied with mechanical connectors, joints type EPKJ and SMOE are supplied without connectors.

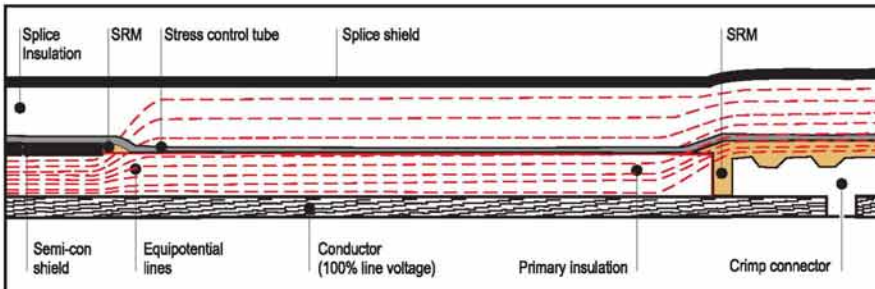

Equi-Potential line behaviour after installation of stress control tubing



Raychem Elastomeric Technology

The elastomeric joint component is supplied in an expanded form, in which the heat-shrinkable outer wall tubing holds the insulation layer at a wide diameter.

Application of heat causes the outer wall tubing to shrink, allowing the insulating layer to contract at the same time and closely fit the joint. Rubber like characteristics of the material enables the joints to follow thermally induced dimensional changes of cable insulation.

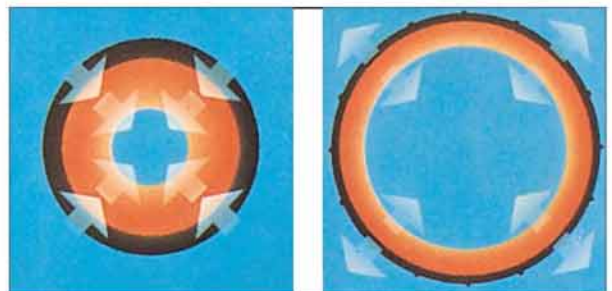

Elastic memory of the material ensures that correct insulation wall thickness is always obtained for the defined application range of component.

Medium Voltage Joints

Raychem Heat Shrinkable 11kV-33 kV jointing system for polymeric and paper cables and transitions

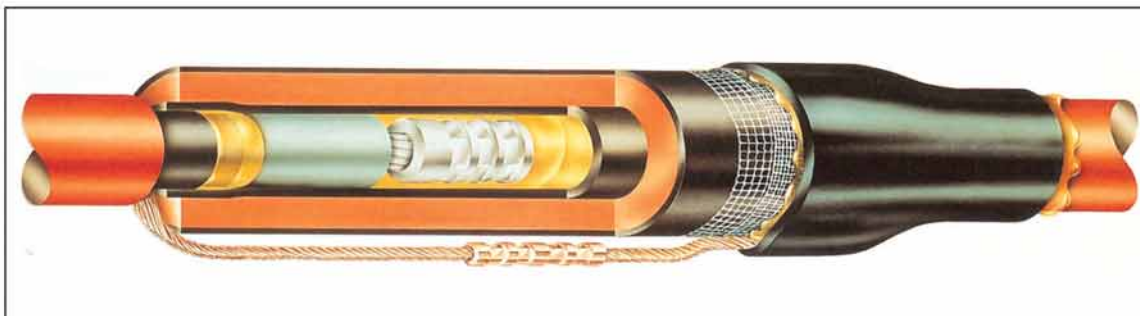

A universal system

Cable preparation and installation techniques for Raychem high voltage joints are identical to those for Raychem heat-shrinkable terminations. The same basic design is also shared by Raychem joints for paper insulated cables. In this respect, too, the heat-shrinkable system sets new standards of efficiency and simplicity.

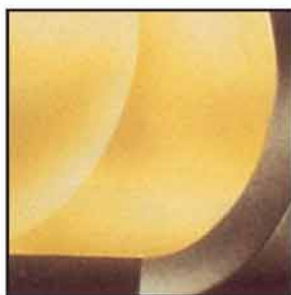

Electrical field control

The stress control tubing has precisely defined impedance characteristic which smoothens the electrical field over connector and cable screen ends. During installation of the tubing, its shrinking action compresses the special void filler (yellow) into position round the screen ends and connector. Pencilling of insulation at the connector is not necessary.

Product design

The design of a single-core joint for polymeric insulated cable is described here. The same design principles are used for 3-core and paper insulated cables.



Insulation and screen

The elastomeric sleeve provides correct thickness of insulation (red) in one step. The insulation screen is provided by the outer wall of the sleeve, which is of heat-shrinkable conductive polymer (black). This technique saves installation time and ensures flawless bond between joint insulation and screen.

Mechanical strength

for steel wire or tape armoured cables. Raychem joints incorporate a light-weight impact-resistant galvanised steel joint case which is quick to install and provides earth fault current capacity.

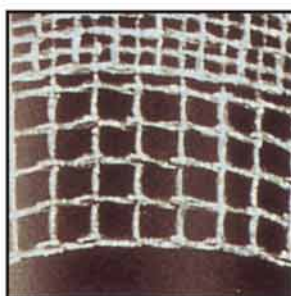

Metallic shielding

Tinned copper mesh of adequate cross-section provides electrical continuity of insulation shield across the connection area.

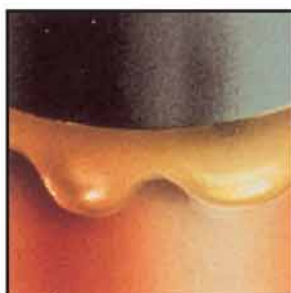

Outer sealing

Heat used to shrink the outer sleeve causes pre-coated adhesive to melt and flow, resulting in lasting moisture and corrosion barrier on the cable oversheath.

Installation procedure

A pre-packed set of components is slid over the prepared cable cores and outer sealing sleeve is parked over the cable. After jointing the conductors, connector and screen ends are electrically smoothed with void filling compound. Stress control tubing and elastomeric components are positioned over the connector and shrunk into place. The cable shield is reinstated with copper mesh and the oversheath by adhesive-coated sealing sleeve. Kits are supplied with illustrated step by step instructions.

72kV High Voltage Terminations

Raychem High Voltage Joints and Terminations

Using its knowledge and experience in the field of material design, Raychem has pioneered some of the most important technical advances in cable accessory technology. Heat shrinkable accessories are well accepted for medium voltage distribution by utilities, equipment manufacturers and industrial users throughout the world for over 40 years.

72kV Outdoor Termination installed in West Bengal Development Corporation Ltd., Bakreshwar



66kV XLPE Outdoor Termination installed in Gujarat Electricity Board, Vadodara

High performance material

Raychem terminations are made of a specially formulated material with excellent tracking and erosion resistance characteristics. Accelerated and natural weathering tests which are constantly carried out at Raychem facilities and independent test sites around the world have demonstrated that terminations are UV and water resistant, and perform reliably even when exposed to sudden temperature variations. Tracking and Erosion Test as per ASTM D2303 and IEC112 confirm the material properties to be suitable for operation in severe climatic conditions.

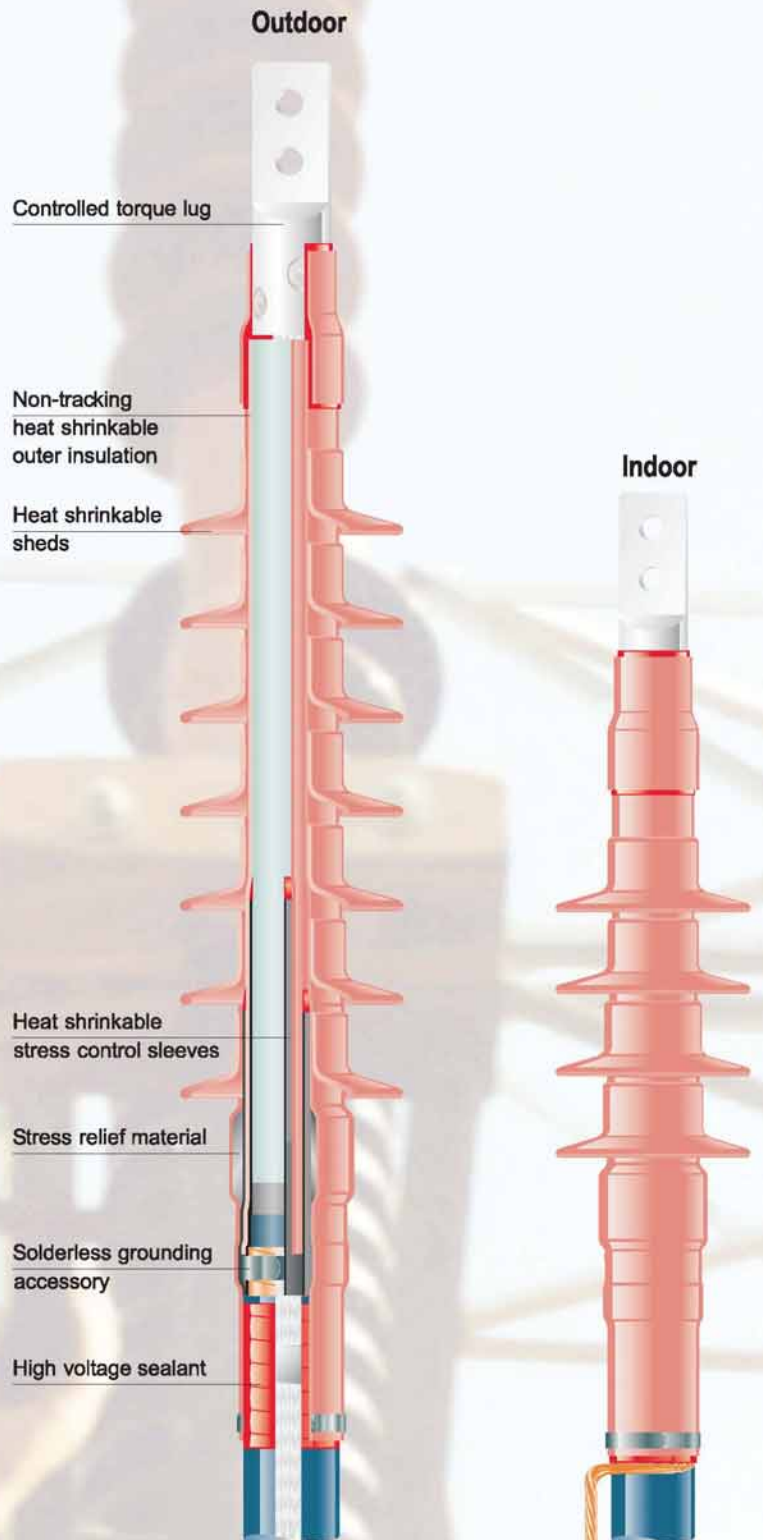

72kV High Voltage Joints

Raychem 72kV elastomeric heat shrinkable joints, a unique system, gives the transmission engineer ease of installation previously only available for medium voltage accessories. 72kV joints from Raychem set the standard for simplicity and reliability.

Product Features & Benefits

- Heat shrink and elastomeric technologies
- Cross-bonding, shield-break and external grounding facilities
- Link boxes for cross-bonding
- Mechanical lugs and connectors
- Joints and terminations have been proven by extensive use in the field
- Testing to international standards under the supervision of independent testing institutes
- Suitable for all polymeric cables

Designed for easy jointing

The Raychem joint design comprises of a connector that allows even large cross-sections to be jointed with two dual wall, heat shrinkable sleeves.

Heavy walled co-extrusion of two layers of red insulation forms the inner sleeve. the outer sleeve consists of a thick layer of red insulation co-extruded under a black outer conductive layer which act as the joint screen.

Controlled torque connector (Mechanical Connector)

The connector design allows cables to be jointed without special tools, heat treatment or filing off after installation. Shear head bolts ensure pre-engineered electrical connection.

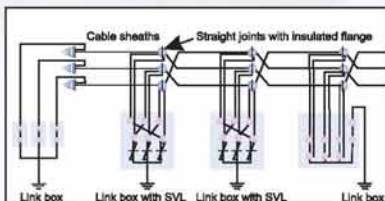

Cross-Bonding

The elastomeric Raychem 72kV joints are suitable for all polymeric cables and can accommodate various cross-bonding shield break and external grounding arrangements.

Earth Link Boxes

For HV joints with facility of copper link, cable entry sealing and Sheath Voltage Limiters (SVL) for earth connection and cross-bonding.

Application

- Direct grounding
- Single point bonding
- Cross-bonding
- Cross-bonding and transposition
- Sheath voltage limiters (SVL)

Features

- Compact design
- Stainless steel
- Hermetically sealed
- 1-phase and 3-phase boxes
- Sheath voltage limiters (SVL)

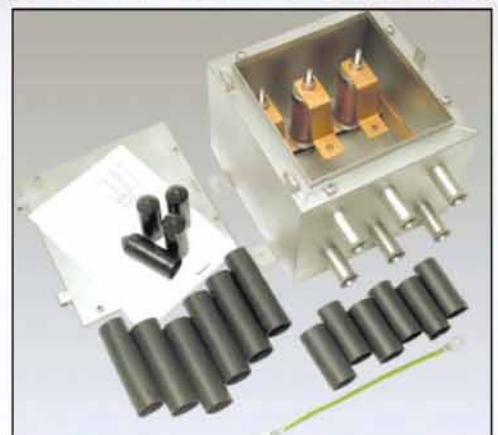
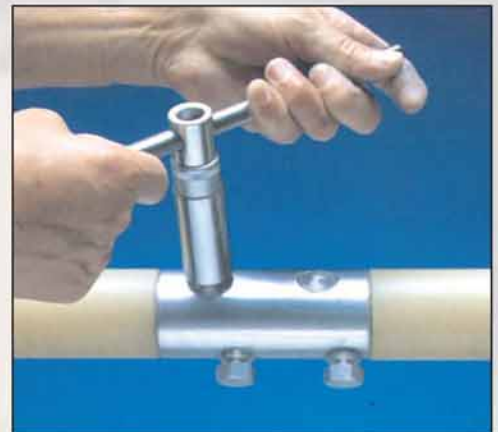

Raysulate

Raychem Insulation Enhancement Systems

Raychem's BBIT/BPTM and HVBT heat shrinkable busbar insulation tubings and tapes provide insulation enhancement and flashover protection. These products can be used on aluminium and copper busbars of circular or rectangular cross-sections. Wall thickness is controlled by the heat shrink process.

BPTM provides flashover protection up to 25kV, whilst the thicker walled BBIT protects up to 36kV. High voltage tests on busbars insulated with BBIT/BPTM tubing demonstrate significant reduction in clearances over conventional air insulated systems.

- Substation protection systems
- Overhead line protection
- Protection and heavy wetting flashover protection
- Bus insulation for low and medium voltage applications
- Customer designed composite hollow insulators
- Operating rods for high voltage equipment
- Suitable for all polymeric cables

Remedy for pollution flashover of insulator

Raysulate Creepage Extenders increase the flashover performance of insulators by reducing surface electric stress and leakage current, and increases the electric strength of insulators.

Installation of creepage extenders:

- increase creepage length
- improve insulator shape
- add high performance polymeric material to the creepage path.



Raychem's Creepage extender installed on a insulator



Raychem's Red Rigid Barrier Board (RRBB) used for phase segregation, to provide higher insulation and protection from flash overs.

Raychem Heat Shrinkable BPTM tubings and HVBT tapes are used for providing insulation where the clearances are inadequate.



Raychem's BCIS vacuum formed sheath used for preventing accidental flashovers due to birds, animals, reptiles, etc.



Insulation of Switchyard with BBIT, BPTM, HVBT and BCIS components



Raysulate



Installation of Silcab-T in ABB-Ring Main Unit



Raychem's Silcab-T is designed to be "re-usable terminal protector" with facilities for on line testing.

The modern switchgears are designed for compactness having small cable compartments with reduced clearances. They require additional protection between phase to phase and phase to ground clearances while connecting cables to bushings.

Copper and Aluminium Insulated Busbars

New designs of switchgear for voltages upto 36kV follow the principle of reducing size as much as possible. Insulated busbars provide maximum protection, particularly in confined spaces, against flashover and accidentally induced discharge. Choosing the right busbar insulation materials can be difficult. Many conventional insulating materials require heavy investment in tooling and do not meet manufacturers' requirements for performance and reliability.

To solve this problem, Raychem RPG has developed series of heat shrinkable tubings for use on aluminium and copper busbars of circular and rectangular cross-sections. These busbar insulation tubings are currently used in switchgear cabinets throughout the world.



Raychem RPG's complete engineering solution for providing insulated busbars

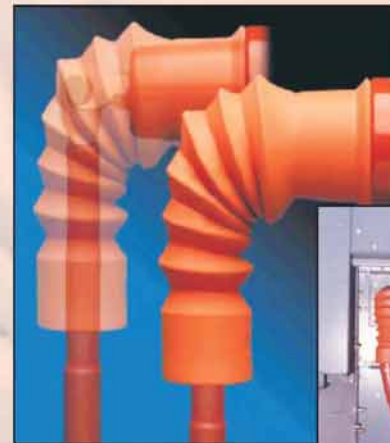

Raychem's cold applied boots installed in Ring Main Unit (R-Cab)

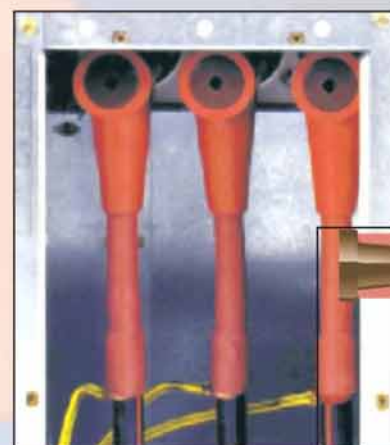

RICS Insulated Connection upto 24kV application

T-Adapter for perpendicular connection of the termination to SF₆-insulated switchgear

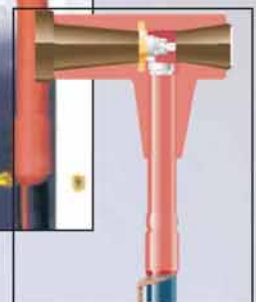

Metal Oxide Gapless Surge Arrester Distribution Class 9kV & 18kV - 5kA.

Metal Oxide Gapless Surge Arresters have been type tested at CPRI as per relevant Indian Standard. Manufactured at our ISO 9001/ ISO 14001 certified facility for quality you can trust for life time. Cerasafe Metal Oxide Gapless Surge Arresters manufactured by Raychem RPG Limited complies to Indian National Standard IS:3070 (Part 3) and International Standard IEC 60099-4.

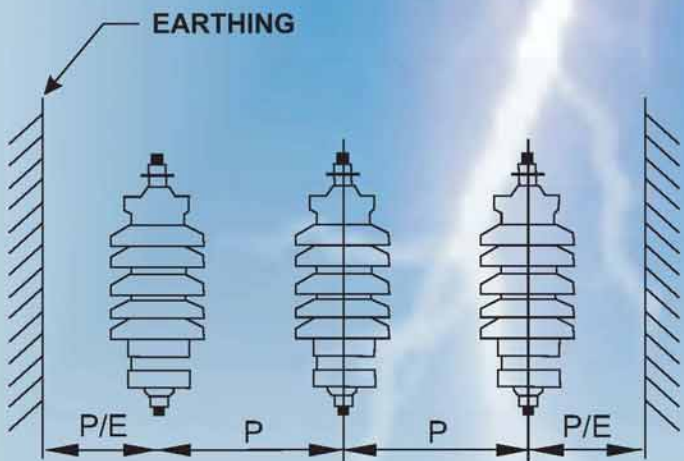
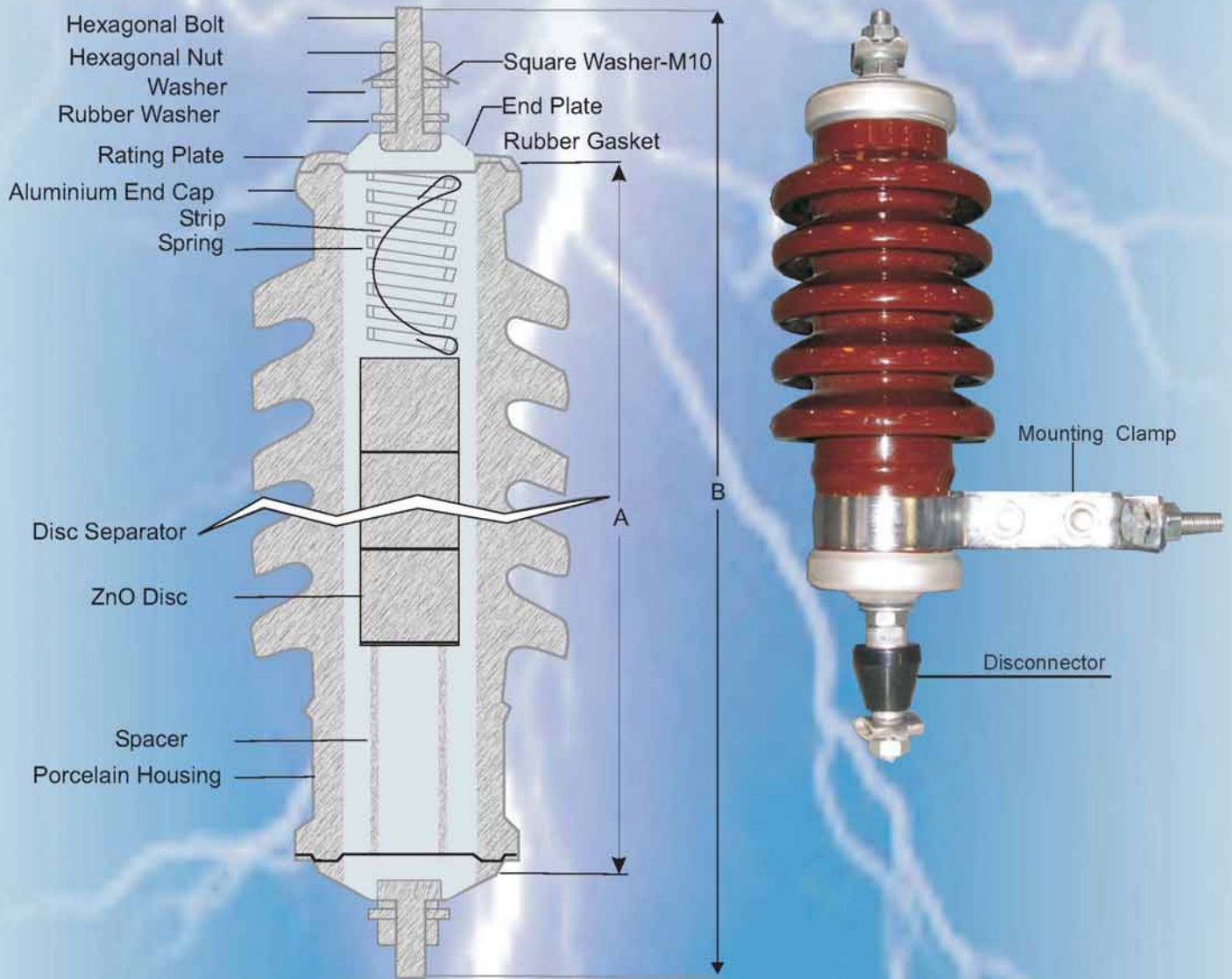

	9kV 5kA	18kV 5kA
Model	CSO 0905	CSO 1805
Weight	2.5 - 3.0 kg.	4.0 - 4.5 kg.
Height "A"	228.5 mm	370 mm
Height "B"	310.0 mm	466 mm
Creepage Distance	300 mm min.	600 mm min.
Phase to Phase	230 mm min.	330 mm min.
Phase to Earth	180 mm min.	280 mm min.

Powerline Protector for Low Voltage applications

Your insurance against

- Power thefts by hooking
- Power outages due to short circuit
- Untoward electrocutions

Anti-theft

Designed with material properties to prevent tapping of overhead bare lines by hooking and other means.

Outage Prevention

Designed to prevent electrical outages caused by trees coming in contact with overhead lines.

Untoward Accidents

Designed to provide necessary insulating cover on bare conductor to prevent accidents due to electrocution.

Cost Effective

Designed to insulate existing bare overhead lines without costly replacement expenditure.

Installation

Possible to install in live condition with help of special tools.



Anytime, anywhere installation, low cost, minimum hassles

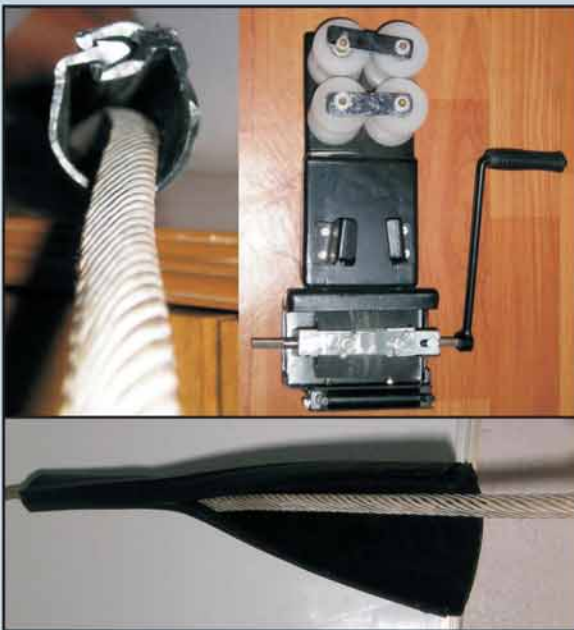

FEATURES

- Sleeve to tubular Interlock design
- Light weight small spool length
- Material
 - Cross Linked Polyethylene
- U.V. and abrasive resistant
- Excellent di-electric properties
- Thermal endurance
- Resistant to bird excrement
- Excellent water repellent property

BENEFITS

Ease of installation. Install directly onto to the existing line. No need for long shut down. No modification of existing overhead lines. No scrapping of existing conductors.

Install as per required length. No need for bulk procurement. Ease of transportation to remote sites. Ease of storage.

Unlimited Shelf life and excellent weather resistant.

No deformation under exposure of sunlight and not prone to abrasion during installation.

Prevents potential accidents where line is close to habitation.

Ability to perform under high temperature

No effect on product life and performance.

No weight gain during monsoon and loss of insulation.

Services

Our qualified staff of engineers, technologist and EHV cable technicians enable Raychem RPG to provide one stop, multi-discipline solutions to power industry all over india.

Services provided by Raychem RPG include

- Route selection and thermal surveys
- Cable structure and support system designs
- Grounding and sheath bonding designs
- Cable installation
- Failure analysis
- Installation of cable joints and terminations
- Cable Spiking and Hipot testing
- Emergency repair services
- Contract maintenance (Cable network maintenance services)
- Customised Insulation solution
- Audits and consultancy of Cable Networks with Utilities and Industries
- Thermo scanning
- Training programs for engineers and jointers
- Partial Discharge Testing

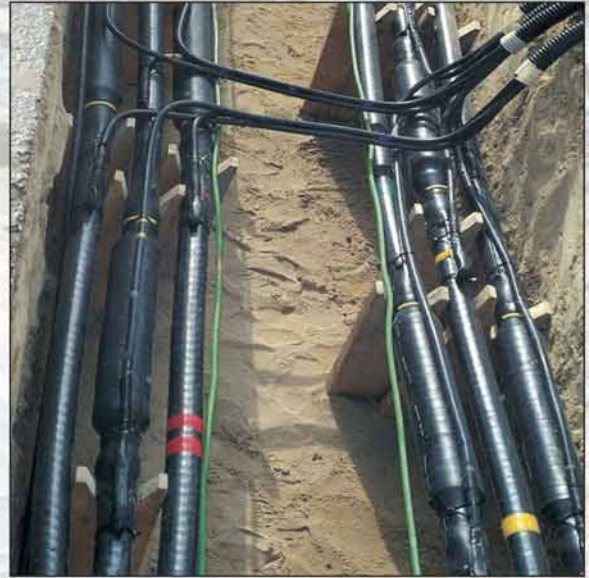

Grounding and sheath bonding designs for EHV cable network



EHV 132kV cable installation work



Rayline centre provides cable management for distribution system



Installation of EHV cable joints

Services



Improper lug connection resulting in heating up

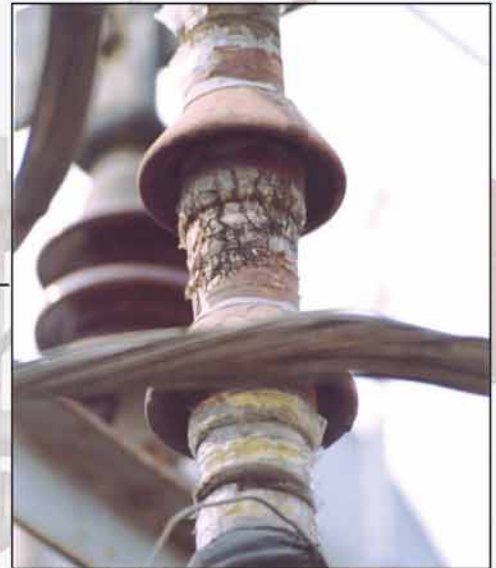

Surface tracking - choice of inferior material for termination

Technical Audit for determining healthiness of cable networks in utilities and industries

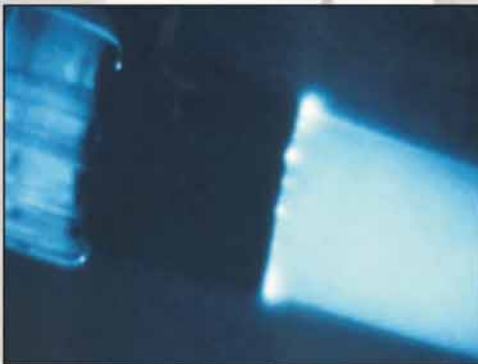

Partial discharge at screen cutback

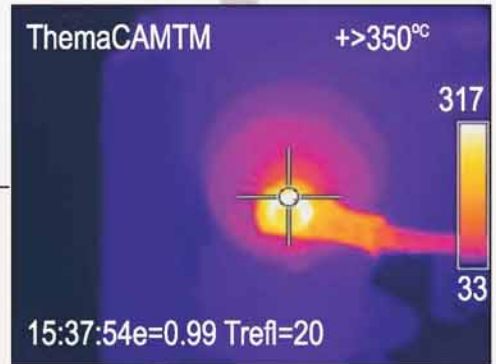

Thermoscanning



D.O fuse before insulation

D.O. Fuse Assembly insulated with BCIC component at Reliance Energy, New Delhi



D.O fuse after insulation

Tools and Accessories

Mechanical connectors, lugs and repair sleeves are designed for use in low and medium voltage applications. Only three sizes cover conductor sizes from 25mm² to 400 mm²

Features & Benefits of mechanical lugs and connectors	Functions
Wide application range	Only three sizes cover conductor cross-sections from 25 mm ² to 400 mm ² and can be used for almost every type of conductor and material
Bodies made of a high tensile, tin plated aluminium alloy Bolts made of special aluminium alloy	Good contact properties Connection between copper and aluminium conductors is possible
Compact design	Requires little installation space, particularly for large sizes
Shear bolts with pre-determined shear torque, hexagon head and specially shaped contact ring	No torque wrench necessary Head shears off when a specific level of torque is applied High tensile strength
Lubricated bolts	Reduces friction Converts tightening torque into contact force for maximum effect
Special features of mechanical connectors Chamfered edges available with and without oil barrier	Suitable for up to 36kV and adaptable to existing joint designs oil stop when used in transition joints



Mechanical connectors installed in straight through joint



Cable end caps for sealing cable ends



Cable entry glands



Tool kit for installation/cable preparation



Heat shrinkable wraparound sleeve for cable sheath repair

Heat Shrinkable **Wraparound sleeves** are a fast, versatile and permanent method of repair for damaged cable outer sheaths. Upon application of heat, the sleeve shrinks and adhesive melts and bonds to the cable sheath, creating permanent seal against moisture entry into the cable.

Wraparound sleeves are useful for repairs to cable outer sheaths where it is not possible to use tubular sleeves.

Capabilities



Training School



Material Testing Laboratory



Product Gallery



Busbar / Surge Arrester Assembly



EHV Testing Laboratory



EHV Testing Laboratory

- Raychem RPG is accredited to ISO 9001: 2000 and ISO 14001 Standards for its manufacturing activities in state-of-the-art plants located at Vasai, Kalher and Rabale, Navi Mumbai.
- These plants are supported by computerized testing facilities and advanced engineering laboratories.
- The Vasai plant houses fully equipped high voltage laboratory capable of testing products having facility of 200kV High Voltage, Impulse and Partial Discharge testing.
- A new manufacturing facility was recently set up for, Busbars, Surge Arresters and Insulators - The **BUSI** Factory at Vasai.
- Product Management facility for EPD Division at Vasai includes a training school for conducting programs for customers, staff and operators. The facility also includes a technical library, product installation laboratory as well as display center for EPD's wide range of products.

Raychem **RPG** Limited

CORPORATE OFFICE

Ceat Mahal Annexe,
463, Dr. A.B. Road, Worli, Mumbai 400 030.
Tel: 91-22-24937485, Fax : 22-24938879

BRANCH OFFICES

MUMBAI

Ceat Mahal Annexe,
463, Dr. A. B. Road Worli,
Mumbai 400 030.
Tel : 91-22-24937485, Fax : 22-24938879

DELHI

510-511 Ansal Bhawan,
16 Kasturba Gandhi Marg
New Delhi 110 001.
Tel : 91-11-41522630, Fax: 11-23354250

BANGALORE

2-C Jubilee Building,
45 Museum Road,
Bangalore 560 025.
Tel : 91-80-51121654, Fax : 80-25586039

KOLKATA

6, Church Lane, First Floor,
Kolkatta 700 001.
Tel : 91-33-22109312, Fax : 33-22109313

CHENNAI

T8, 3rd Floor, Apollo Dubai Plaza,
100 Mahalingapuram Main Road,
Nungambakkam, Chennai 600 034.
Tel: 91-44-55718441, Fax : 44-28173840

OPERATIONS

1/62 M.G. Road,
Bassein Taluka, Vasai
Dist. Thane 401 208.
Tel : 91-250-2480048, Fax : 250-2480046

INDUSTRIAL ELECTRONICS DIVISION

R-508, TTC Industrial Area,
M.I.D.C. Rabale,
Navi Mumbai 400 708.
Tel: 91-22-56166318, Fax : 22-27642444

SERVICES

CUSTOMER CARE CENTRE

H-22-26, Rajan Warehouse,
Jai Matadi Compound PO Kalher,
Bhiwandi 421 302, District Thane.
Tel: 91-2522-275340, Fax : 2522-274289

RAYLINE CENTRE (I)

405, B-8 GD-ITL Tower,
Netaji Subhash Place, Pritampura
Delhi 110 034.
Tel : 91-11-55159298

RAYLINE CENTRE (II)

B-6 Pamposh Enclave
Nehru Place
New Delhi 110 019
Tel : 91-11-51730569



Vasai Operations

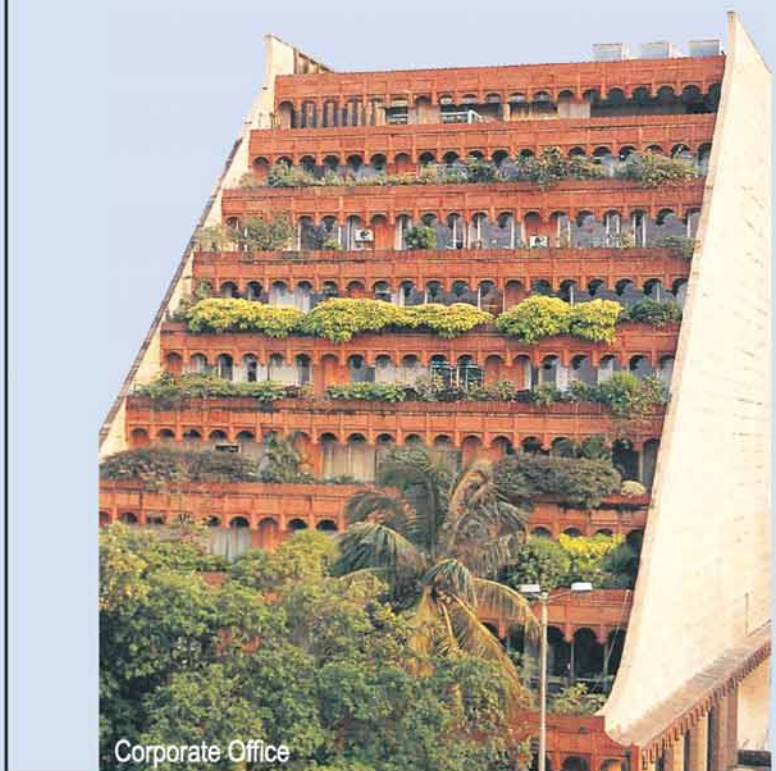

Corporate Office

*For detailed information or specific enquiries,
please contact Raychem RPG's nearest office.*

Visit us at www.raychemrpg.com