

Panasonic

EUROPA

PRECISION.
PERFECTION.
PERFORMANCE.



EUROPA





Presenting the EUROPA Series, a range of switches that have been designed to provide convenience along with perfect functionality. EUROPA Series, a range of switches that complement your strong aesthetic sense. While its list of features seems endless, it is the elegant look and finish of the switches that is most striking.

Give your home a touch of elegance with EUROPA.

classy

STYLE ON
WITH PERFECTION



A finish that's so crisp and contemporary. It undeniably sits in your space without fighting for attention, yet making everything look so classy. If your definition of style is sophistication, class and minimalism, well, this one's made just for your walls.





glare

SHINE ON
WITH GLASS



Match or contrast or simply make it stand out. Creativity to decorate and art. Use clear and glass plates to accentuate the wall designs and patterns. Add some dramatic accessories to your walls.



metal

SWITCH ON
WITH DAZZLE



An epitome of luxury, metallic always makes your space a tad more stylish. When things dazzle, a statement is made. Add an touch of class with the Metallic look.



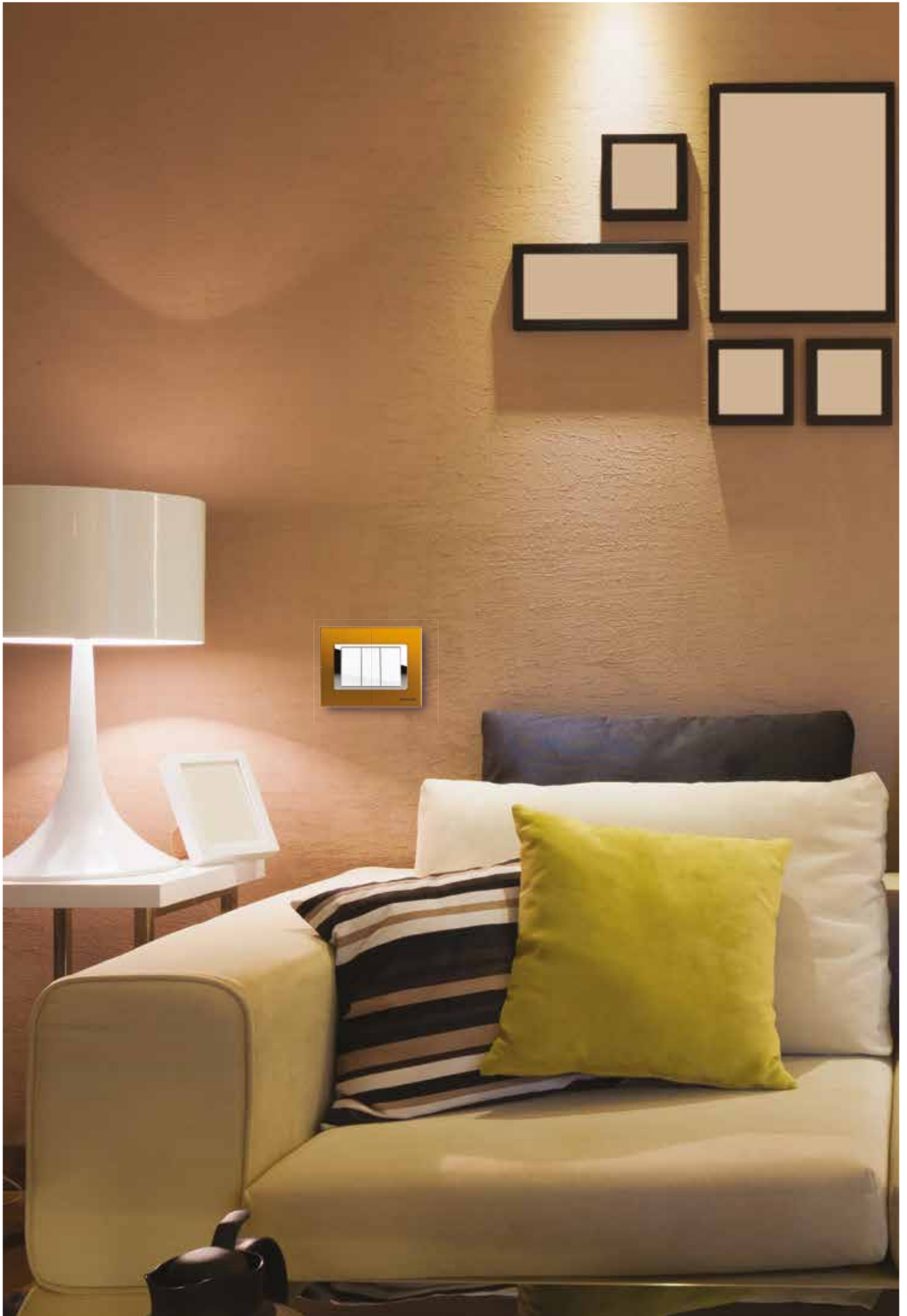

Flame Retardant

- Flame retardant (Resist fire)
- Difficult to mould therefore duplicacy of product is very difficult
- Urea formaldehyde has high flame retardant properties as compared to PC or other thermoplastic



Front Polycarbonate of (V0 Grade)



Back Piece Urea Material



Super Glossy Finish



- Premium look
- Dust does not settle easily
- Glossiness readings = > G140
- Almost matches glossiness of glass plate



Toggle Type Structure

- 1 Pillar Terminals (Brass + Silver Flash)
- 2 Terminal Screws (Brass + Silver Flash)
- 3 Contact Bridge (Brass)
- 4 Switch Housing (Urea)

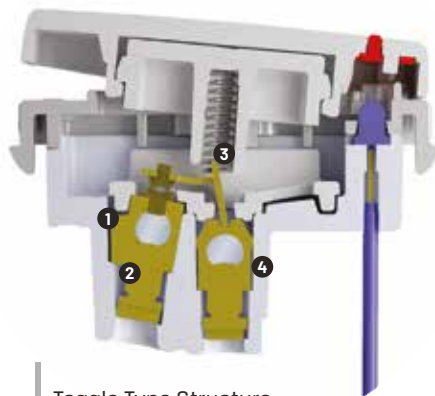

Toggle Type Structure



Normal Switch Structure

- Increased life and smooth operation
- Less Sound
- Less Bounce
- Contact Gap = Mini Gap

Switch - Moving Contact Tip Properties

"AgCdO" bimetal rivets offers increased resistance to welding and erosion.

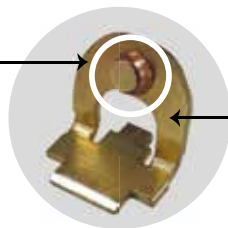

Brass moving contact prevents rusting of the part, and offers better dimensional stability throughout its life.

"All Sockets with Safety Shutter"

Child safety against electric shock.
Smooth insertion & withdrawal of plugs.

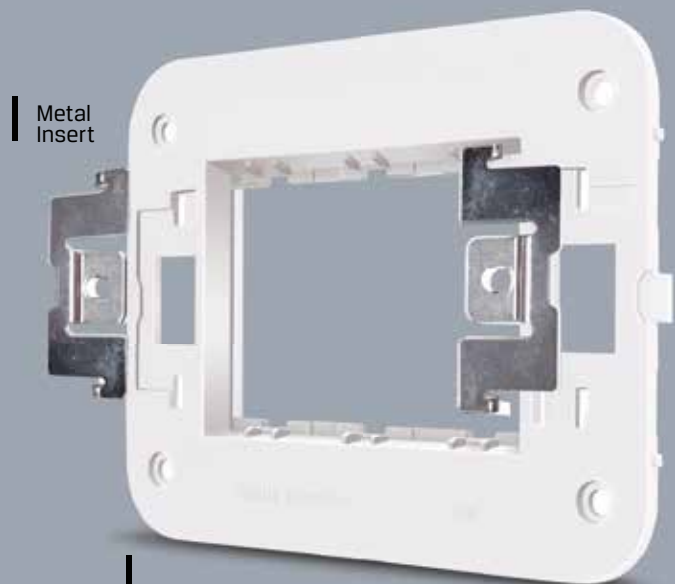

Plate Structure

Plate fitment with metal inserts



Plate



Base Frame

- Improve overall strength of the inner frame
- Sturdy plates
- Reduces possibility of plate damages

Slim & Sleek Design

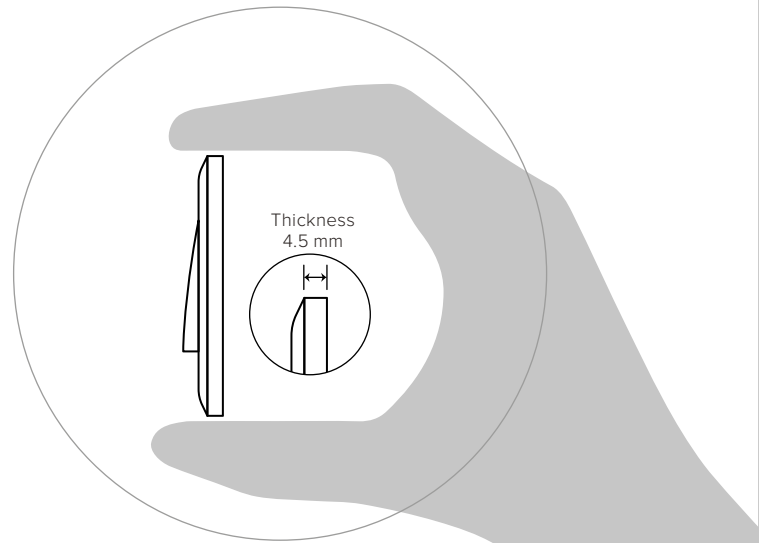
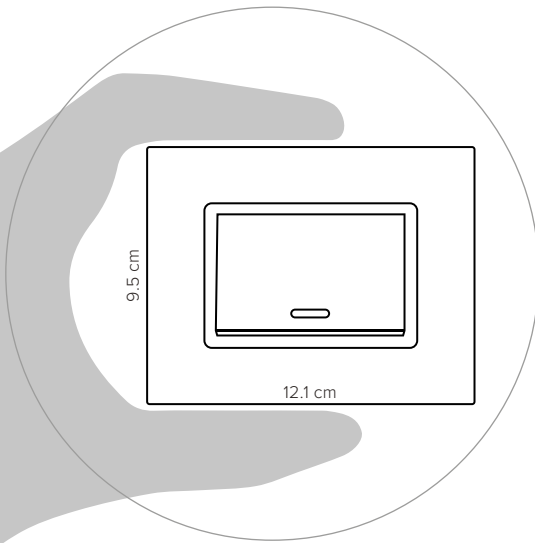

- Better Aesthetic
- Blends with the wall and gives a very sleek look

Low Operational Sound

Switches with reduced sound

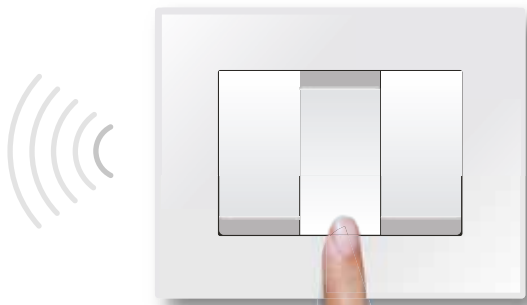

- Sound level < 65 Db
- Soft operational sound

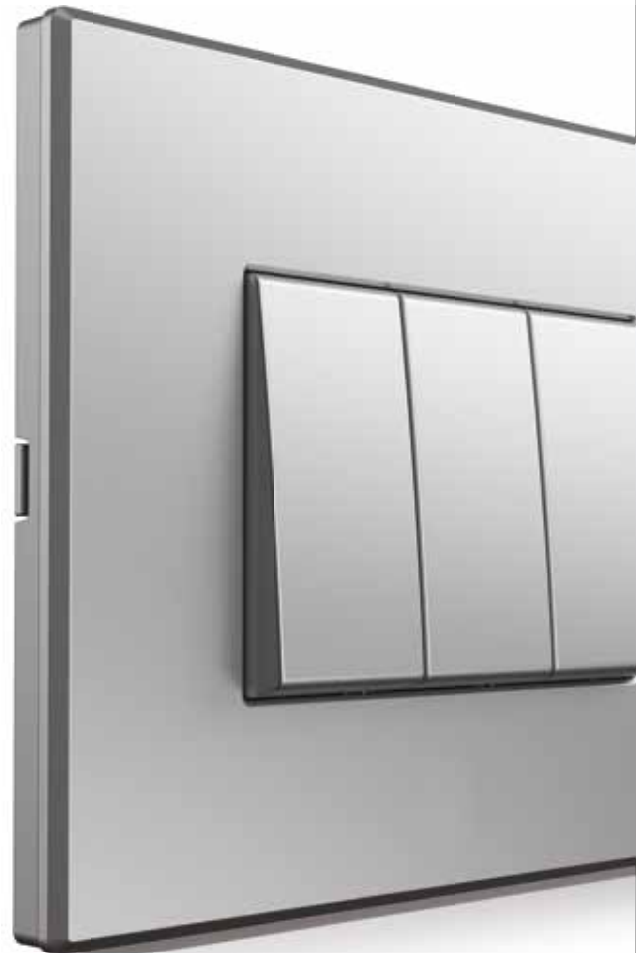

Front Removal Accessories



Easy installation from the front



Easy removal from the front

- Easy to install and uninstall the accessories
- No need to remove the inner frame from metal box and hence it is safe & saves time

1 Lac Operations

- Product durability
- No need to worry for years to come

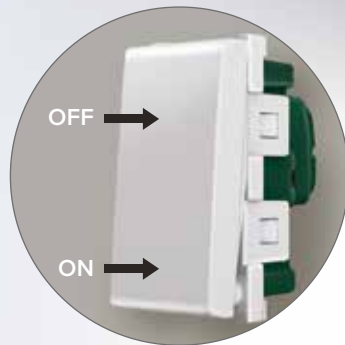

IP20 Protection

- No live part is exposed to fingers and can be accessible only through screwdriver
- Protects against solid object larger than 12mm
- Completely insulated construction



RoHS Compliant

Panasonic is committed towards making a positive & proactive contribution to the community.

So we highly pays attention to protect global environment and relieve environmental load from our business operation, complying with the RoHS directive.

Restriction of Hazardous Substances (RoHS) regulations set limits for the use of following substances

- Lead (Pb)
- Cadmium (Cd)
- Mercury (Hg)
- Hexavalent Chromium (Cr+6)
- Specified Brominated Flame Retardants (PBB, PBDE)
- Phthalates - Four kinds: (DEHP, BBP, DBP, DIBP)



100%
ECO Friendly







Increase
Production
Efficiency







Improve
Quality

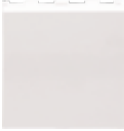

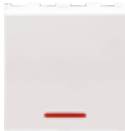







10AX Switches (240V-50Hz), ISI

						
Code	WIPM5011	WIPM5111	WIPM5012	WIPM50119	WIPM51119	WIPM5021
Description	10AX, 1Way Switch, 1 Module	10AX, 1Way Switch with Indicator, 1 Module	10AX, 2Way Switch, 1 Module	10A, Bell Push Switch, 1 Module	10A, Bell Push Switch with Indicator, 1 Module	10AX, 1Way Switch, 2 Module
HSN	85361010	85361010	85361010	85361010	85361010	85361010
Unit Sale Price Rs per number	176	231	208	229	298	249
Maximum Retail Price (Inclusive of all taxes) Rs.	3520	4620	4160	4580	5960	2490
Standard Packing Quantity (Number)	20	20	20	20	20	10



					
Code	WIPM5121	WIPM5022	WIPM50219	WIPM51219	WIPM51319
Description	10AX, 1Way Switch with Indicator, 2 Module	10AX, 2Way Switch, 2 Module	10A, Bell Push Switch, 2 Module	10A, Bell Push Switch with Indicator, 2 Module	10A, Bell Push Switch with Indicator, 3 Module
HSN	85361010	85361010	85361010	85361010	85361010
Unit Sale Price Rs per number	275	287	287	342	385
Maximum Retail Price (Inclusive of all taxes) Rs.	2750	2870	2870	3420	1925
Standard Packing Quantity (Number)	10	10	10	10	5

20A Switches (240V-50Hz), ISI

						
Code	WIPM50115	WIPM51115	WIPM50125	WIPM50215	WIPM51215	WIPM50225
Description	20A, 1Way Switch, 1 Module	20A, 1Way Switch with Indicator, 1 Module	20A, 2Way Switch, 1 Module	20A, 1Way Switch, 2 Module	20A, 1Way Switch with Indicator, 2 Module	20A, 2Way Switch, 2 Module
HSN	85361020	85361020	85361020	85361020	85361020	85361020
Unit Sale Price Rs per number	278	290	326	349	455	355
Maximum Retail Price (Inclusive of all taxes) Rs.	5560	5800	6520	3490	4550	3550
Standard Packing Quantity (Number)	20	20	20	10	10	10

			
Code	WIPM50315	WIPM51315	WIPM50325
Description	20A, 1Way Switch, 3 Module	20A, 1Way Switch with Indicator, 3 Module	20A, 2Way Switch, 3 Module
HSN	85361020	85361020	85361020
Unit Sale Price Rs per number	410	511	505
Maximum Retail Price (Inclusive of all taxes) Rs.	2050	2555	2525
Standard Packing Quantity (Number)	5	5	5

Power Switches - Heavy Duty (240V-50Hz), ISI

		
Code	WIPM51113	WIPM51234
Description	25A, S.P, 1Way Switch with Indicator, 1 Module	32A, D.P, 1Way Switch with Indicator, 2 Module
HSN	85361020	85361020
Unit Sale Price Rs per number	521	909
Maximum Retail Price (Inclusive of all taxes) Rs.	5210	9090
Standard Packing Quantity (Number)	10	10

Sockets with Safety Shutter (240V~50Hz)



Code	WIPM1081*	WIPM113214	WIPM1062*	WIPM123214	WIPM1432*	WIPM125214
Description	10A, 2Pin Uro Socket, 1 Module	6A, 3Pin Socket (ISI), 2 Module	10A, Multi Socket, 2 Module	16A, 3Pin Socket (ISI), 2 Module	25A, 3Pin Socket, 2 Module	16A/6A, Twin Socket, (ISI Mark), 2 Module
HSN	85366910	85366910	85366910	85366910	85366910	85366910
Unit Sale Price Rs per number	210	247	289	397	464	481
Maximum Retail Price (Inclusive of all taxes) Rs.	4200	2470	2890	3970	4640	4810
Standard Packing Quantity (Number)	20	10	10	10	10	10



Code	WIPM1172*	WIPM155314	WIPM1253*	WIPM4734
Description	13A/10A/6A, Combi Socket for all Pins, 2 Module	Twin Socket, 3 Module (ISI Mark), 6A/16A, 240V~	Twin Socket, 3 Module, 10A/20A, 240V~	25A, Motor Starter Switch, 2 Module
HSN	85366910	85366910	85366910	85395000
Unit Sale Price Rs per number	376	561	434	652
Maximum Retail Price (Inclusive of all taxes) Rs.	3760	2805	2170	6520
Standard Packing Quantity (Number)	10	5	5	10

Fan Regulators & Dimmers (240V~50Hz)



Code	WIPM4951	WIPM4952	WIPM495214	WIPM5714	WIPM5726
Description	100W, Step Fan Regulator, 1 Module	100W, Step Fan Regulator, 2 Module	100W, Step Fan Regulator, 2 Module (ISI)	450W, Dimmer, 1 Module	650W, Dimmer, 2 Module
HSN	84149030	84149030	84149030	85365020	85365020
Unit Sale Price Rs per number	661	914	952	773	946
Maximum Retail Price (Inclusive of all taxes) Rs.	13220	9140	9520	15460	9460
Standard Packing Quantity (Number)	20	10	10	20	10







Support Modules (240V~50Hz)











Code	WIPM2164	WIPM2264	WIPM2499	WIPM2488	WIPM24886	WIPM3023
Description	RJ11, Tel Jack, Single with Shutter, 1 Module	RJ11, Tel Jack, Double w/o Shutter, 1 Module	RJ45, Receptor, 1 Module	RJ45, Computer Socket, Cat 5e, 1 Module	RJ45, Computer Socket, Cat 6, 1 Module	Cord Outlet with Grip, 1 Module
HSN	85366910	85366910	85366910	85366910	85366910	85366910
Unit Sale Price Rs per number	209	349	203	670	786	236
Maximum Retail Price (Inclusive of all taxes) Rs.	4180	6980	4060	13400	15720	4720
Standard Packing Quantity (Number)	20	20	20	20	20	20

*Limited Stock, to be discontinued.



Support Modules (240V~50Hz)

						
Code	WIPM2501	WIPM4702	WIPM3020	WIPM3120	WIPM3032R	WIPM3032N
Description	TV Socket Outlet, 1 Module	Buzzer, 2 Module	Blank Plate, 1 Module	Blank Plate, 2 Module	Indicator - LED (Red), 1 Module	Indicator - LED (Natural), 1 Module
HSN	85365090	85318000	85389000	85389000	85395000	85395000
Unit Sale Price Rs per number	217	656	49	82	276	276
Maximum Retail Price (Inclusive of all taxes) Rs.	4340	6560	2450	1640	2760	2760
Standard Packing Quantity (Number)	20	10	50	20	10	10







						
Code	WIPM3032G	WIPM2731	WIPM1342	WIPM1341	WIPM2641	WIPM4822
Description	Indicator - LED (Green), 1 Module	Satellite Socket	USB-A Charger, Double Port(2.0A, 5V DC), 2 Module	USB-A Charger, Single Port(2.1A, 5V DC), 1 Module	High Definition Multimedia Interface Connector, 1 Module	Audio Video Socket, 1 Module
HSN	85395000	85365090	85044090	85044090	85444999	85365090
Unit Sale Price Rs per number	276	547	976	1599	1654	788
Maximum Retail Price (Inclusive of all taxes) Rs.	2760	5470	5856	31980	16540	7880
Standard Packing Quantity (Number)	10	10	6	20	10	10

			
Code	WIPM1443	WIPM1343	WIPM2311
Description	18W, USB Power Delivery Charger(USB-C), 1 Module (CRS Certified)	18W, USB Type-A Fast Charger, 1 Module (CRS Certified)	Projector Socket, 1 Module
HSN	85365090	85044090	85044090
Unit Sale Price Rs per number	1886	1794	2090
Maximum Retail Price (Inclusive of all taxes) Rs.	37720	35880	20900
Standard Packing Quantity (Number)	20	20	10

Hospitality Range (240V~50Hz)

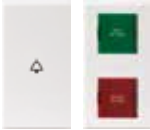
		
Code	WIPM4661	WIPM791
Description	3.5 Modulem Audio Jack, White	Bell Call Indicator, 1 Module
HSN	85444299	85444299
Unit Sale Price Rs per number	1685	443
Maximum Retail Price (Inclusive of all taxes) Rs.	25275	4430
Standard Packing Quantity (Number)	15	10

Hospitality Range (240V~50Hz)

						
Code	WIPM57812	WIPM500212	WIPM500213	WIPM1051	WIPM4013 / WIPM40131	WIPM4014 / WIPM40141
Description	20A, Electronic Key-card Unit with 30Sec time delay, 3 Module	DND MMR Internal unit (DND Switch, MMR Switch), 2 Module	DND MMR External unit (DND Indicator, MMR Indicator & Bell Push Switch), 2 Module	20VA, Shaver Socket with Transformer (With White Inner Frame), 4 Module	Foot Light - LED Based (Cool & Warm light), 3 Module	Foot Light - LED Based (Cool & Warm light), 4 Module
HSN	85365090	85365090	85365090	85365090	94054090	85444299
Unit Sale Price Rs per number	3048	851	1135	3349	821	773
Maximum Retail Price (Inclusive of all taxes) Rs.	18288	4255	5675	3349	4926	4638
Standard Packing Quantity (Number)	6	5	5	1	6	6

10AX Switches (240V~50Hz), ISI



Code	WIPM5011B	WIPM5111B	WIPM5012B	WIPM50119B	WIPM51119B	WIPM5021B
Description	10AX, 1Way Switch, 1 Module	10AX, 1Way Switch with Indicator, 1 Module	10AX, 2Way Switch, 1 Module	10A, Bell Push Switch, 1 Module	10A, Bell Push Switch with Indicator, 1 Module	10AX, 1Way Switch, 2 Module
HSN	85361010	85361010	85361010	85361010	85361010	85361010
Unit Sale Price Rs per number	194	256	229	253	328	274
Maximum Retail Price (Inclusive of all taxes) Rs.	3880	5120	4580	5060	6560	2740
Standard Packing Quantity (Number)	20	20	20	20	20	10



Code	WIPM5121B	WIPM5022B	WIPM50219B	WIPM51219B	WIPM51319B
Description	10AX, 1Way Switch with Indicator, 2 Module	10AX, 2Way Switch, 2 Module	10A, Bell Push Switch, 2 Module	10A, Bell Push Switch with Indicator, 2 Module	10A, Bell Push Switch with Indicator, 3 Module
HSN	85361010	85361010	85361010	85361010	85361010
Unit Sale Price Rs per number	301	316	316	377	423
Maximum Retail Price (Inclusive of all taxes) Rs.	3010	3160	3160	3770	2115
Standard Packing Quantity (Number)	10	10	10	10	5

20A Switches (240V~50Hz), ISI



Code	WIPM50115B	WIPM51115B	WIPM50125B	WIPM50215B	WIPM51215B	WIPM50225B
Description	20A, 1Way Switch, 1 Module	20A, 1Way Switch with Indicator, 1 Module	20A, 2Way Switch, 1 Module	20A, 1Way Switch, 2 Module	20A, 1Way Switch with Indicator, 2 Module	20A, 2Way Switch, 2 Module
HSN	85361020	85361020	85361020	85361020	85361020	85361020
Unit Sale Price Rs per number	307	318	358	383	501	391
Maximum Retail Price (Inclusive of all taxes) Rs.	6140	6360	7160	3830	5010	3910
Standard Packing Quantity (Number)	20	20	20	10	10	10



Code	WIPM50315B	WIPM51315B	WIPM50325B
Description	20A, 1Way Switch, 3 Module	20A, 1Way Switch with Indicator, 3 Module	20A, 2Way Switch, 3 Module
HSN	85361020	85361020	85361020
Unit Sale Price Rs per number	449	563	555
Maximum Retail Price (Inclusive of all taxes) Rs.	2245	2815	2775
Standard Packing Quantity (Number)	5	5	5

Power Switches - Heavy Duty (240V~50Hz), ISI



Code	WIPM51113B	WIPM51234B
Description	25A, S.P, 1Way Switch with Indicator, 1 Module	32A, D.P, 1Way Switch with Indicator, 2 Module
HSN	85361020	85361020
Unit Sale Price Rs per number	572	1002
Maximum Retail Price (Inclusive of all taxes) Rs.	5720	10020
Standard Packing Quantity (Number)	10	10

Sockets with Safety Shutter (240V-50Hz)



Code	WIPM1081B*	WIPM113214B	WIPM1062B*	WIPM123214B	WIPM1432B*	WIPM125214B
Description	10A, 2Pin Uro Socket, 1 Module	6A, 3Pin Socket (ISI), 2 Module	10A, Multi Socket, 2 Module	16A, 3Pin Socket (ISI), 2 Module	25A, 3Pin Socket, 2 Module	16A/6A, Twin Socket, (ISI Mark), 2 Module
HSN	85366910	85366910	85366910	85366910	85366910	85366910
Unit Sale Price Rs per number	231	273	317	438	510	528
Maximum Retail Price (Inclusive of all taxes) Rs.	4620	2730	3170	4380	5100	5280
Standard Packing Quantity (Number)	20	10	10	10	10	10



Code	WIPM1172B*	WIPM155314B	WIPM1253B*	WIPM4734B
Description	13A/10A/6A, Combi Socket for all Pins, 2 Module	Twin Socket, 3 Module (ISI Mark), 6A/16A, 240V-	Twin Socket, 3 Module, 10A/20A, 240V-	25A, Motor Starter Switch, 2 Module
HSN	85366910	85366910	85366910	85395000
Unit Sale Price Rs per number	415	616	476	718
Maximum Retail Price (Inclusive of all taxes) Rs.	4150	3080	2380	7180
Standard Packing Quantity (Number)	10	5	5	10

Fan Regulators & Dimmers (240V-50Hz)









Code	WIPM4951B	WIPM4952B	WIPM495214B	WIPM5714B	WIPM5726B
Description	100W, Step Fan Regulator, 1 Module	100W, Step Fan Regulator, 2 Module	100W, Step Fan Regulator, 2 Module (ISI)	450W, Dimmer, 1 Module	650W, Dimmer, 2 Module
HSN	84149030	84149030	84149030	85365020	85365020
Unit Sale Price Rs per number	727	1005	1046	850	1041
Maximum Retail Price (Inclusive of all taxes) Rs.	14540	10050	10460	17000	10410
Standard Packing Quantity (Number)	20	10	10	20	10







Support Modules (240V-50Hz)









Code	WIPM2164B	WIPM2264B	WIPM2499B	WIPM2488B	WIPM24886B	WIPM3023B
Description	RJ11, Tel Jack, Single with Shutter, 1 Module	RJ11, Tel Jack, Double w/o Shutter, 1 Module	RJ45, Receptor, 1 Module	RJ45, Computer Socket, Cat 5e, 1 Module	RJ45, Computer Socket, Cat 6, 1 Module	Cord Outlet with Grip, 1 Module
HSN	85366910	85366910	85366910	85366910	85366910	85366910
Unit Sale Price Rs per number	229	384	225	737	865	260
Maximum Retail Price (Inclusive of all taxes) Rs.	4580	7680	4500	14740	17300	5200
Standard Packing Quantity (Number)	20	20	20	20	20	20



Support Modules (240V~50Hz)

						
Code	WIPM2501B	WIPM4702B	WIPM3020B	WIPM3120B	WIPM2731B	WIPM1342B
Description	TV Socket Outlet, 1 Module	Buzzer, 2 Module	Blank Plate, 1 Module	Blank Plate, 2 Module	Satellite Socket	USB-A Charger, Double Port(2.0A, 5V DC), 2 Module
HSN	85365090	85318000	85389000	85389000	85365090	85044090
Unit Sale Price Rs per number	241	722	56	91	602	976
Maximum Retail Price (Inclusive of all taxes) Rs.	4820	7220	2800	1820	6020	5856
Standard Packing Quantity (Number)	20	10	50	20	10	6







						
Code	WIPM1341B	WIPM2641B	WIPM4822B	WIPM1443B	WIPM1343B	WIPM2311B
Description	USB-A Charger, Single Port(2.1A, 5V DC), 1 Module	High Definition Multimedia Interface Connector, 1 Module	Audio Video Socket, 1 Module	18W, USB Power Delivery Charger(USB-C), 1 Module (CRS Certified)	18W, USB Type-A Fast Charger, 1 Module (CRS Certified)	Projector Socket, 1 Module
HSN	85044090	85444999	85365090	85365090	85044090	85044090
Unit Sale Price Rs per number	1764	1948	866	2076	1978	2298
Maximum Retail Price (Inclusive of all taxes) Rs.	35280	19480	8660	41520	39560	22980
Standard Packing Quantity (Number)	20	10	10	20	20	10

Hospitality Range (240V~50Hz)

						
Code	WIPM57812B	WIPM500212B	WIPM500213B	WIPM1051B	WIPM4013B / WIPM40131B	WIPM4014B / WIPM40141B
Description	20A, Electronic Key-card Unit with 30Sec time delay, 3 Module	DND MMR Internal unit (DND Switch, MMR Switch), 2 Module	DND MMR External unit (DND Indicator, MMR Indicator & Bell Push Switch), 2 Module	20VA, Shaver Socket with Transformer (With White Inner Frame), 4 Module	Foot Light - LED Based (Cool & Warm light), 3 Module	Foot Light - LED Based (Cool & Warm light), 4 Module
HSN	85365090	85365090	85365090	85365090	94054090	85444299
Unit Sale Price Rs per number	3352	936	1248	3684	903	851
Maximum Retail Price (Inclusive of all taxes) Rs.	20112	4680	6240	18420	5418	5106
Standard Packing Quantity (Number)	6	5	5	5	6	6







		
Code	WIPM4661B	WIPM791B
Description	3.5 Modem Audio Jack, White	Bell Call Indicator, 1 Module
HSN	85444299	85444299
Unit Sale Price Rs per number	1747	443
Maximum Retail Price (Inclusive of all taxes) Rs.	26305	4430
Standard Packing Quantity (Number)	15	10



10AX Switches (240V~50Hz), ISI

						
Code	WIPM5011S	WIPM5111S	WIPM5012S	WIPM50119S	WIPM51119S	WIPM5021S
Description	10AX, 1Way Switch, 1 Module	10AX, 1Way Switch with Indicator, 1 Module	10AX, 2Way Switch, 1 Module	10A, Bell Push Switch, 1 Module	10A, Bell Push Switch with Indicator, 1 Module	10AX, 1Way Switch, 2 Module
HSN	85361010	85361010	85361010	85361010	85361010	85361010
Unit Sale Price Rs per number	194	256	229	253	328	274
Maximum Retail Price (Inclusive of all taxes) Rs.	3880	5120	4580	5060	6560	2740
Standard Packing Quantity (Number)	20	20	20	20	20	10

					
Code	WIPM5121S	WIPM5022S	WIPM50219S	WIPM51219S	WIPM51319S
Description	10AX, 1Way Switch with Indicator, 2 Module	10AX, 2Way Switch, 2 Module	10A, Bell Push Switch, 2 Module	10A, Bell Push Switch with Indicator, 2 Module	10A, Bell Push Switch with Indicator, 3 Module
HSN	85361010	85361010	85361010	85361010	85361010
Unit Sale Price Rs per number	301	316	316	377	423
Maximum Retail Price (Inclusive of all taxes) Rs.	3010	3160	3160	3770	2115
Standard Packing Quantity (Number)	10	10	10	10	5

20A Switches (240V~50Hz), ISI







						
Code	WIPM50115S	WIPM51115S	WIPM50125S	WIPM50215S	WIPM51215S	WIPM50225S
Description	20A, 1Way Switch, 1 Module	20A, 1Way Switch with Indicator, 1 Module	20A, 2Way Switch, 1 Module	20A, 1Way Switch, 2 Module	20A, 1Way Switch with Indicator, 2 Module	20A, 2Way Switch, 2 Module
HSN	85361020	85361020	85361020	85361020	85361020	85361020
Unit Sale Price Rs per number	307	318	358	383	501	391
Maximum Retail Price (Inclusive of all taxes) Rs.	6140	6360	7160	3830	5010	3910
Standard Packing Quantity (Number)	20	20	20	10	10	10

			
Code	WIPM50315S	WIPM51315S	WIPM50325S
Description	20A, 1Way Switch, 3 Module	20A, 1Way Switch with Indicator, 3 Module	20A, 2Way Switch, 3 Module
HSN	85361020	85361020	85361020
Unit Sale Price Rs per number	449	563	555
Maximum Retail Price (Inclusive of all taxes) Rs.	2245	2815	2775
Standard Packing Quantity (Number)	5	5	5

Power Switches - Heavy Duty (240V~50Hz), ISI





		
Code	WIPM51113S	WIPM51234S
Description	25A, S.P, 1Way Switch with Indicator, 1 Module	32A, D.P, 1Way Switch with Indicator, 2 Module
HSN	85361020	85361020
Unit Sale Price Rs per number	572	1002
Maximum Retail Price (Inclusive of all taxes) Rs.	5720	10020
Standard Packing Quantity (Number)	10	10

Sockets With Safety Shutter (240V~50Hz)







						
Code	WIPM1081S*	WIPM113214S	WIPM1062S*	WIPM123214S	WIPM1432S*	WIPM125214S
Description	10A, 2Pin Uro Socket, 1 Module	6A, 3Pin Socket (ISI), 2 Module	10A, Multi Socket, 2 Module	16A, 3Pin Socket (ISI), 2 Module	25A, 3Pin Socket, 2 Module	16A/6A, Twin Socket, (ISI Mark), 2 Module
HSN	85366910	85366910	85366910	85366910	85366910	85366910
Unit Sale Price Rs per number	231	273	317	438	510	528
Maximum Retail Price (Inclusive of all taxes) Rs.	4620	2730	3170	4380	5100	5280
Standard Packing Quantity (Number)	20	10	10	10	10	10

				
Code	WIPM1172S*	WIPM155314S	WIPM1253S*	WIPM4734S
Description	13A/10A/6A, Combi Socket for all Pins, 2 Module	Twin Socket, 3 Module (ISI Mark), 6A/16A, 240V-	Twin Socket, 3 Module, 10A/20A, 240V-	25A, Motor Starter Switch, 2 Module
HSN	85366910	85366910	85366910	85395000
Unit Sale Price Rs per number	415	616	434	718
Maximum Retail Price (Inclusive of all taxes) Rs.	4150	6160	2170	7180
Standard Packing Quantity (Number)	10	10	5	10

Fan Regulators & Dimmers (240V~50Hz)

					
Code	WIPM4951S	WIPM4952S	WIPM495214S	WIPM5714S	WIPM5726S
Description	100W, Step Fan Regulator, 1 Module	100W, Step Fan Regulator, 2 Module	100W, Step Fan Regulator, 2 Module (ISI)	450W, Dimmer, 1 Module	650W, Dimmer, 2 Module
HSN	84149030	84149030	84149030	85365020	85365020
Unit Sale Price Rs per number	727	1005	1046	850	1041
Maximum Retail Price (Inclusive of all taxes) Rs.	14540	10050	10460	17000	10410
Standard Packing Quantity (Number)	20	10	10	20	10







Hospitality Range (240V~50Hz)

						
Code	WIPM2164S	WIPM2264S	WIPM2499S	WIPM2488S	WIPM24886S	WIPM3023S
Description	RJ11, Tel Jack, Single with Shutter, 1 Module	RJ11, Tel Jack, Double w/o Shutter, 1 Module	RJ45, Receptor, 1 Module	RJ45, Computer Socket, Cat 5e, 1 Module	RJ45, Computer Socket, Cat 6, 1 Module	Cord Outlet with Grip, 1 Module
HSN	85366910	85366910	85366910	85366910	85366910	85366910
Unit Sale Price Rs per number	229	384	225	737	865	260
Maximum Retail Price (Inclusive of all taxes) Rs.	4580	7680	4500	14740	17300	5200
Standard Packing Quantity (Number)	20	20	20	20	20	20







*Limited Stock, to be discontinued.



Support Modules (240V ~50Hz)

						
Code	WIPM2501S	WIPM4702S	WIPM3020S	WIPM3120S	WIPM2731S	WIPM1342S
Description	TV Socket Outlet, 1 Module	Buzzer, 2 Module	Blank Plate, 1 Module	Blank Plate, 2 Module	Satellite Socket	USB-A Charger, Double Port(2.0A, 5V DC), 2 Module
HSN	85365090	85318000	85389000	85389000	85365090	85044090
Unit Sale Price Rs per number	241	722	56	91	602	976
Maximum Retail Price (Inclusive of all taxes) Rs.	4820	7220	2800	1820	6020	5856
Standard Packing Quantity (Number)	20	10	50	20	10	6

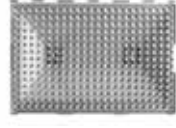
						
Code	WIPM1341S	WIPM2641S	WIPM4822S	WIPM1443S	WIPM1343S	WIPM2311S
Description	USB-A Charger, Single Port(2.1A, 5V DC), 1 Module	High Definition Multimedia Interface Connector, 1 Module	Audio Video Socket, 1 Module	18W, USB Power Delivery Charger(USB-C), 1 Module (CRS Certified)	18W, USB Type-A Fast Charger, 1 Module (CRS Certified)	Projector Socket, 1 Module
HSN	85044090	85444999	85365090	85365090	85044090	85044090
Unit Sale Price Rs per number	1764	1948	866	2076	1978	2298
Maximum Retail Price (Inclusive of all taxes) Rs.	35280	19480	8660	41520	39560	22980
Standard Packing Quantity (Number)	20	10	10	20	20	10

Hospitality Range (240V ~50Hz)

						
Code	WIPM57812S	WIPM500212S	WIPM500213S	WIPM1051S	WIPM4013S / WIPM40131S	WIPM4014S / WIPM40141S
Description	20A, Electronic Key-card Unit with 30Sec time delay, 3 Module	DND MMR Internal unit (DND Switch, MMR Switch), 2 Module	DND MMR External unit (DND Indicator, MMR Indicator & Bell Push Switch), 2 Module	20VA, Shaver Socket with Transformer (With White Inner Frame), 4Module	Foot Light - LED Based (Cool & Warm light), 3 Module	Foot Light - LED Based (Cool & Warm light), 4 Module
HSN	85365090	85365090	85365090	85365090	94054090	85444299
Unit Sale Price Rs per number	3352	936	1248	3684	903	851
Maximum Retail Price (Inclusive of all taxes) Rs.	20112	4680	6240	18420	5418	5106
Standard Packing Quantity (Number)	6	5	5	5	6	6

		
Code	WIPM4661S	WIPM791S
Description	3.5 Modulem Audio Jack, Silver	Bell Call Indicator, 1 Module
HSN	85444299	85444299
Unit Sale Price Rs per number	1747	443
Maximum Retail Price (Inclusive of all taxes) Rs.	17470	4430
Standard Packing Quantity (Number)	10	10

CLEAR PLATES

(HSN Code - 85381090)



COLOUR	MODULE	1 Module	2 Module	3 Module	4 Module	6 Module	8 Module Horizontal	8 Module Square	12 Module	16 Module	18 Module
Gold	CODE	WIPM-6011MGD	WIPM-6012MGD	WIPM-6013MGD	WIPM-6014MGD	WIPM-6016MGD	WIPM-6018MGD	WIPM-6024MGD	WIPM-6026MGD	WIPM-6028MGD	WIPM-6036MGD
Unit Sale Price Rs per number		1049	1049	1269	1487	2145	2617	2617	3591	4062	4346
Maximum Retail Price (Inclusive of all taxes) Rs.		5245	5245	6345	7435	10725	13085	13085	17955	20310	21730
Brushed Aluminium	CODE	WIP-M6011MBA	WIP-M6012MBA	WIP-M6013MBA	WIP-M6014MBA	WIP-M6016MBA	WIP-M6018MBA	WIP-M6024MBA	WIP-M6026MBA	WIP-M6028MBA	WIP-M6036MBA
Unit Sale Price Rs per number		903	903	1163	1364	1967	2398	2398	3293	3725	3986
Maximum Retail Price (Inclusive of all taxes) Rs.		4515	4515	5815	6820	9835	11990	11990	16465	18625	19930
Standard Packing Quantity (Number)		5	5	5	5	5	5	5	5	5	5

Weatherproof Box (IP55)



Code	WIPM6812H	WIPM6813H	WIPM6814H
Description	2M, Weatherproof Box (IP55)	3M, Weatherproof Box (IP55)	4M, Weatherproof Box (IP55)
HSN	85365090	85365090	85365090
Unit Sale Price Rs per number	1489	1594	1700
Maximum Retail Price (Inclusive of all taxes) Rs.	1	1	1
Standard Packing Quantity (Number)	1489	1594	1700

Do not use "Hard cleaning Agent" for cleaning purpose

Note : Antimicrobial series is also available through pre order





PANASONIC LIFE SOLUTIONS INDIA PVT LTD.

Corporate & Head Office: 3rd Floor, B Wing, I-Think Techno Campus,
Pokharan Road No.2, Thane (W), Thane - 400 607, Maharashtra.

Tel 022 4222 8888 | Fax 022 4222 8884

Customer Care no.: 022-41304130 | WhatsApp: 9136028606

Email: wecare@in.panasonic.com | www.isin.panasonic.com

Registered Office: 12th Floor, Ambience Tower, Ambience Island,
NH-48, Gurugram - 122 002, Haryana.

Dealer Stamp